



INSTALLATION

Optimale Lösungen für industrielle Beleuchtung und Leitungsführung – sowohl im Elektroinstallationshandwerk, als auch im Maschinen- und Schaltschrankbau.

Diesem Anspruch wird LICATEC als inhabergeführtes mittelständisches Unternehmen mit hoher Flexibilität und kurzen Entscheidungswegen schon seit mehr als 40 Jahren gerecht.

Wir entwickeln und produzieren innovative und montagefreundliche Systeme, um unseren Kunden die Arbeit zu erleichtern.

Über unser gut ausgebautes internationales Vertriebsnetz gewährleisten wir die kompetente Beratung vor Ort, unsere Zentrallogistik sichert die schnelle und termingerechte Belieferung, oft bis direkt auf die Baustelle.

Weltweit vertrauen, mit weiterhin stark steigender Tendenz, bereits mehr als 5000 Kunden unseren Produkten und unserem Service – für uns ein großer Ansporn, den eingeschlagenen Weg konsequent weiter zu verfolgen.

Alle technischen Daten, Abbildungen und Preisangaben wurden sorgfältig erstellt. Irrtümer vorbehalten. Technische Änderungen, die der Weiterentwicklung dienen, behalten wir uns vor. Alle Maßangaben sind in mm.

Unsere Lieferungs- und Zahlungsbedingungen finden Sie im Internet unter www.licatec.de/agb.

The provision of optimal solutions for industrial lighting and cable conduit systems – both in the electrical installation trade as well as in mechanical engineering and switch cabinet construction.

The owner-managed medium-sized company LICATEC has been meeting these requirements for more than 40 years with its high degree of flexibility and short decision-making paths.

We develop and produce innovative and easy to install systems which make our client's work easier.

Our well-developed international sales network enables us to guarantee competent local advice and our central logistics secures the fast on time delivery, often onto the construction site.

More than 5000 customers world wide place their trust in our products and our service, and that with a growing tendency – this is a great motivation for us to consistently continue along this road.

All technical data and illustrations have been prepared with care. Errors excepted. We reserve the right to make any technical modifications which serve further development. All dimensions are in mm.

Please see www.licatec.de/agb for reference regarding our Terms of Delivery and Payment.

Inhalt



CK Minikanäle, Hart PVC / CK Mini Trunkings, rigid PVC	4 - 5
CK Bauhöhe 40 mm, Hart PVC / CK 40 mm height, rigid PVC	6 - 7
CK Bauhöhe 60 mm, Hart PVC / CK 60 mm height, rigid PVC	8 - 9
CK halogenfrei, PC-ABS / CK halogen-free, PC-ABS	10 - 11
CKE „Elegant“, Hart PVC / CKE „Elegant“, rigid PVC	12 - 13
CKA, Aluminium / CKA, made of aluminium	14 - 15
CKS, Stahlblech / CKS, made of sheet steel	16 - 17
CK Zubehör / CK Accessories	18
CKA/CKS Zubehör / CKA/CKS Accessories	19

CK Minikanäle, Hart PVC / CK Mini Trunkings, rigid PVC

Installationskanäle aus Hart-PVC / Installation Trunkings, rigid PVC

VDE   RoHS konform/compliant

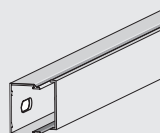
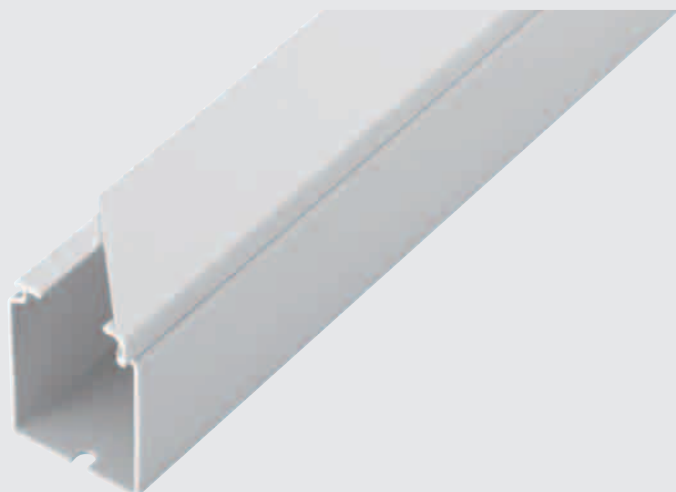

20 x 10

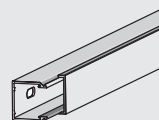

15 x 15

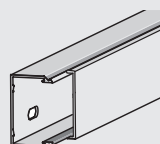

30 x 15

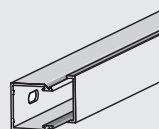

18 x 18

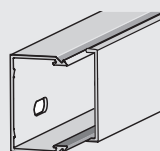

40 x 25

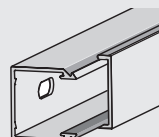

30 x 30

Material: Hart-PVC, schwer entflammbar, selbstverlöschend

Besondere Merkmale:

- Farben ähnlich: weiß RAL 9001, reinweiß RAL 9010, lichtgrau RAL 7035
- Lieferumfang: Unterteil mit Bodenlochungen (Abstand 125 mm), inkl. Deckel, Länge 2 m

Material: rigid PVC, hardly-inflammable, self-extinguishing

Specific Features:

- Colors similar: white RAL 9001, pure white RAL 9010, light grey RAL 7035
- Extent of supply: base with perforated bottom (distance 125 mm), incl. cover, length 2 m

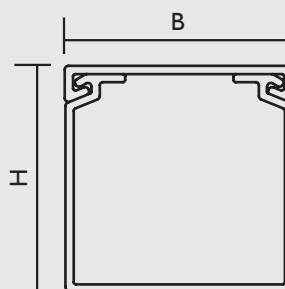

Farbe Colour	Abmessungen Dimensons B x H / W x H	Länge Length	VE PU	Artikel-Nr. Article-No.
RAL 9001	20 x 10	2 m	160	1256
RAL 7035	20 x 10	2 m	160	1254
RAL 9010	20 x 10	2 m	160	1255
RAL 9001	15 x 15	2 m	140	9000
RAL 7035	15 x 15	2 m	140	9004
RAL 9010	15 x 15	2 m	140	9005
RAL 9001	30 x 15	2 m	70	9010
RAL 7035	30 x 15	2 m	70	9014
RAL 9010	30 x 15	2 m	70	9015
RAL 9001	18 x 18	2 m	96	9007
RAL 7035	18 x 18	2 m	96	9008
RAL 9010	18 x 18	2 m	96	9009
RAL 9001	40 x 25	2 m	48	9020
RAL 7035	40 x 25	2 m	48	9024
RAL 9010	40 x 25	2 m	48	9025
RAL 9001	30 x 30	2 m	50	9030
RAL 7035	30 x 30	2 m	50	9034
RAL 9010	30 x 30	2 m	50	9035

CK Bauhöhe 40 mm, Hart PVC /

CK 40 mm height, rigid PVC

Installationskanäle aus Hart-PVC / Installation Trunkings, rigid PVC

CE  **RoHS konform / compliant**

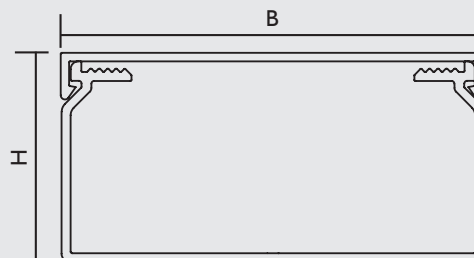
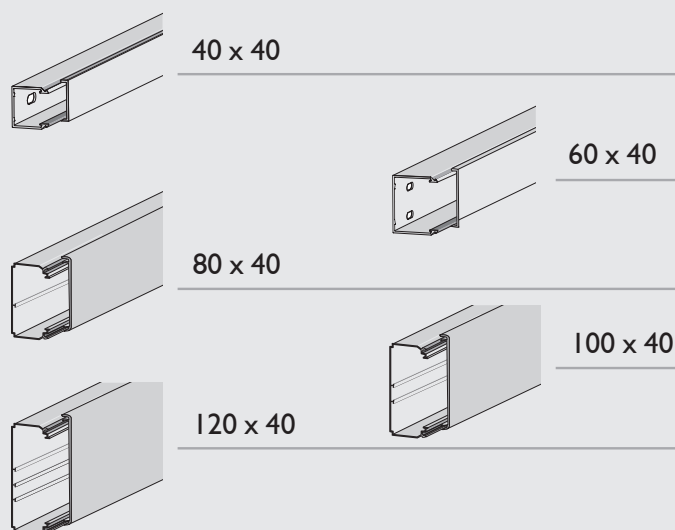

Material: Hart-PVC, schwer entflammbar, selbstverlöschend

Besondere Merkmale:

- Lieferumfang: Unterteil mit Bodenlochungen inkl. Deckel, Länge 2 m
- Ab 80 x 40 mm mit 2 Kabelklammern

Material: rigid PVC, hardly-inflammable, self-extinguishing

Specific Features:

- Extent of supply: base with perforated bottom incl. cover, length 2 m
- From 80 x 40 mm onwards with 2 cable holders

Trennstege / Dividers

Typ Type	Artikel-Nr. Article-No.
80/100/120 x 40	9053

Farbe Colour	Abmessungen Dimensions B x H / W x H	Länge Length	VE PU	Artikel-Nr. Article-No.
RAL 9001	40 x 40	2 m	32	9100
RAL 7035	40 x 40	2 m	32	9104
RAL 9010	40 x 40	2 m	32	9105
RAL 9001	60 x 40	2 m	28	9200
RAL 7035	60 x 40	2 m	28	9204
RAL 9010	60 x 40	2 m	28	9205
RAL 9010	80 x 40	2 m	10	1105
RAL 9010	100 x 40	2 m	8	1305
RAL 9010	120 x 40	2 m	8	2105

Symbolische Darstellungen:

Artikel-Nr. / Article-No.			
Außeneck Outside Corner	Inneneck Inside Corner	Flachwinkel Flat Corner	Endstück End Cap
-	-	-	-
-	-	-	-
-	-	-	-
9210	9220	9240	9230
9214	9224	9244	9234
9215	9225	9245	9235
1115	1125	1145	1135
1315	1325	1345	1335
2115	2125	2145	2135



Außenecken
Outside Corners

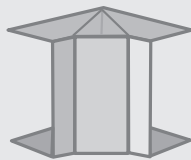

Innenecken
Inside Corners

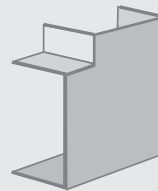

Flachwinkel
Flat Corners

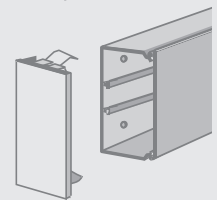

Endstücke
End Caps

Kabelklammern / Cable Clamps

Typ Type	Artikel-Nr. Article-No.
80 x 40	9096
100 x 40	9097
120 x 40	9098

Abzweigstücke / Branch-off Pieces

Typ Type	Artikel-Nr. Article-No.
80 x 40	1185
100 x 40	1385
120 x 40	2185

CK Bauhöhe 60 mm, Hart PVC / CK 60 mm height, rigid PVC

Installationskanäle aus Hart-PVC / Installation Trunkings, rigid PVC

VDE   RoHS konform / compliant

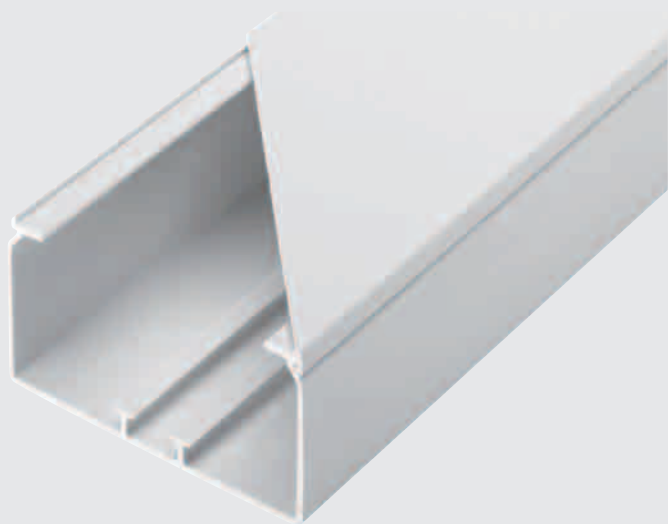

Material: Hart-PVC, schwer entflammbar,
selbstverlöschend

Besondere Merkmale:

- Vorgesehen für Trennstegeinbau ab 60 x 60 mm
- Farben ähnlich: weiß RAL 9001, reinweiß RAL 9010, lichtgrau RAL 7035
- Lieferumfang: Unterteil mit Bodenlochungen (Abstand 125 mm), inkl. Deckel, Länge 2 m
- Ab 60 x 60 mm mit 4 Kabelklammern

Material: rigid PVC, hardly-inflammable, self-extinguishing

Specific Features:

- Designed for the use of dividers from 60 x 60 mm onwards
- Colors similar: white RAL 9001, pure white RAL 9010, light grey RAL 7035
- Extent of supply: base with perforated bottom (distance 125 mm), incl. cover, length 2 m
- From 60 x 60 mm onwards with 4 cable holders

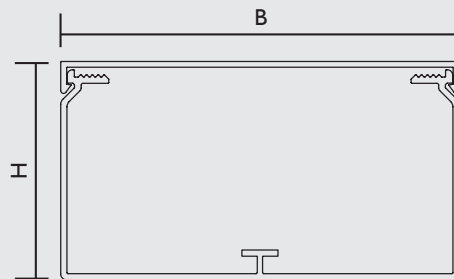
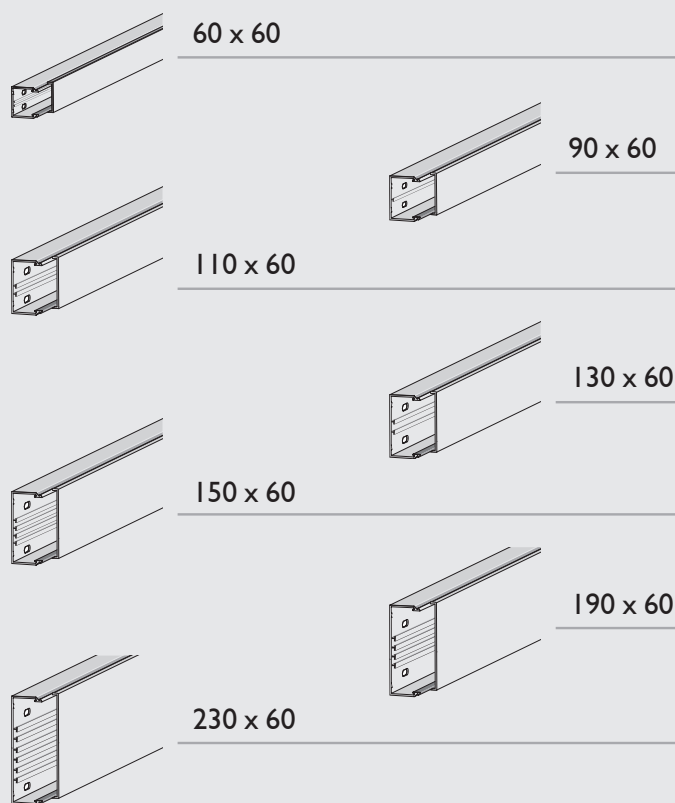

Farbe Colour	Abmessungen Dimensions B x H / W x H	Länge Length	VE PU	Artikel-Nr. Article-No.
RAL 9001	60 x 60	2 m	24	9300
RAL 7035	60 x 60	2 m	24	9304
RAL 9010	60 x 60	2 m	24	9305
RAL 9001	90 x 60	2 m	24	9390
RAL 7035	90 x 60	2 m	24	9394
RAL 9010	90 x 60	2 m	24	9395
RAL 9001	110 x 60	2 m	16	9400
RAL 7035	110 x 60	2 m	16	9404
RAL 9010	110 x 60	2 m	16	9405
RAL 9001	130 x 60	2 m	12	9500
RAL 7035	130 x 60	2 m	12	9504
RAL 9010	130 x 60	2 m	12	9505
RAL 9001	150 x 60	2 m	12	9600
RAL 7035	150 x 60	2 m	12	9604
RAL 9010	150 x 60	2 m	12	9605
RAL 9001	190 x 60	2 m	14	9700
RAL 7035	190 x 60	2 m	14	9704
RAL 9010	190 x 60	2 m	14	9705
RAL 9001	230 x 60	2 m	8	9800
RAL 7035	230 x 60	2 m	8	9804
RAL 9010	230 x 60	2 m	8	9805

Symbolische Darstellungen:

Artikel-Nr. / Article-No.			
Außenecken Outside Corners	Innenecken Inside Corners	Flachwinkel Flat Corners	Endstücke End Caps
9310	9320	9340	9330
9314	9324	9344	9334
9315	9325	9345	9335
9350	9360	9370	9380
9354	9364	9374	9384
9355	9365	9375	9385
9410	9420	9440	9430
9414	9424	9444	9434
9415	9425	9445	9435
9510	9520	9540	9530
9514	9524	9544	9534
9515	9525	9545	9535
9610	9620	9640	9630
9614	9624	9644	9634
9615	9625	9645	9635
9710	9720	9740	9730
9714	9724	9744	9734
9715	9725	9745	9735
9810	9820	9840	9830
9814	9824	9844	9834
9815	9825	9845	9835



Außenecken
Outside Corners

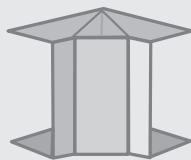

Innenecken
Inside Corners

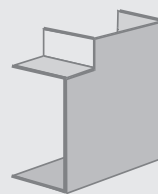

Flachwinkel
Flat Corners

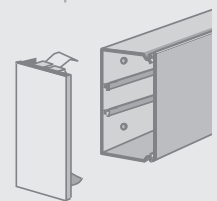

Endstücke
End Caps

CK halogenfrei, PC-ABS / CK halogen-free, PC-ABS

Installationskanäle aus halogenfreiem Kunststoff / Installation Trunkings, made of halogen-free plastic

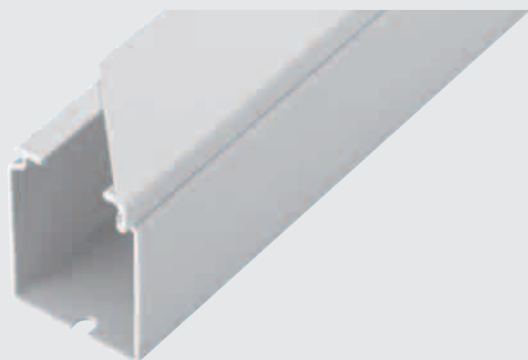

Licatec Installationskanal CK entsprechen EN 50085. Diese Serie wird aus halogenfreiem Kunststoff gem. VDE 0472, Teil 815 gefertigt. Das Material setzt im Brandfall keine toxischen Gase frei. Temperaturbeständigkeit -25°C bis $+75^{\circ}\text{C}$.

Besondere Merkmale:

- Farbe ähnlich: reinweiß, RAL 9010
- Vorgesehen für Trennstegeinbau ab 90×60 mm
- Lieferumfang : Unterteil mit Bodenlochung (Abstand 125 mm) inkl. Deckel Länge 2 m
- Ab 90×60 mm mit 4 Kabelklammern

Licatec installation trunkings CK are in accordance with EN 50085. This series is made of halogen-free plastic, comply with VDE 0472, part 815. In case of a fire this material does not set free any toxic gases. Temperature-resistant -25°C up to $+75^{\circ}\text{C}$.

Specific Features:

- Colour similar: pure white, RAL 9010
- Designed for the use of dividers from 90×60 mm onwards
- Extent of supply: base with perforated bottom (distance 125 mm), incl. Cover, length 2 m
- From 90×60 mm onwards with 4 cable holders

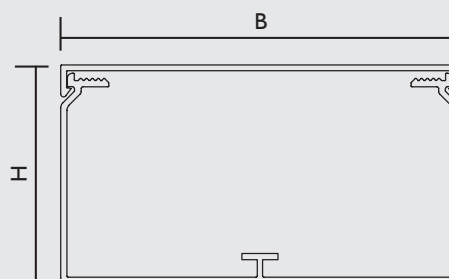
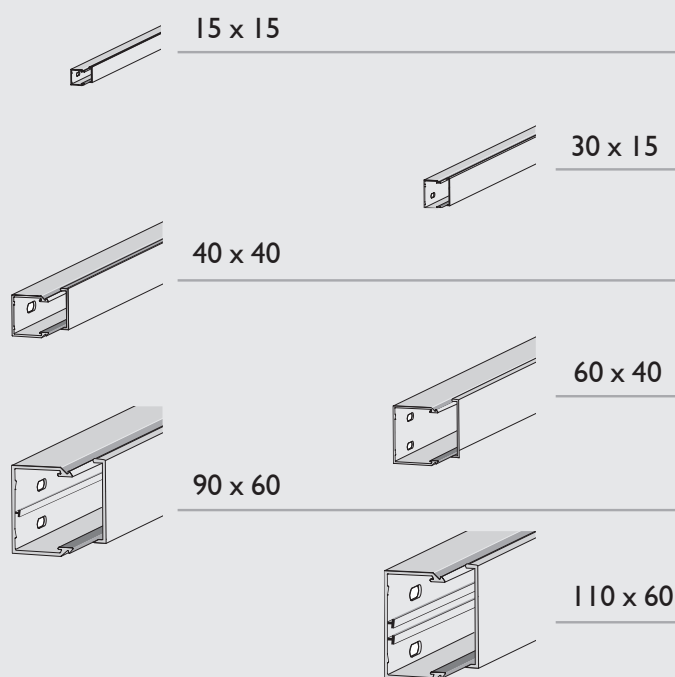

Farbe Colour	Abmessungen Dimensions B x H / W x H	Länge Length	VE PU	Artikel-Nr. Article-No.
RAL 9010	15 x 15	2 m	140	1605
RAL 9010	30 x 15	2 m	70	1625
RAL 9010	40 x 40	2 m	32	1645
RAL 9010	60 x 40	2 m	28	1655
RAL 9010	90 x 60	2 m	24	1665
RAL 9010	110 x 60	2 m	16	1675

Symbolische Darstellungen:

Artikel-Nr. / Article-No.			
Außenecken Outside Corners	Innenecken Inside Corners	Flachwinkel Flat Corners	Endstücke End Caps
-	-	-	-
-	-	-	-
-	-	-	-
9215	9225	9245	9235
9355	9365	9375	9385
9415	9425	9445	9435



Außenecken
Outside Corners

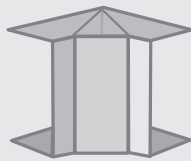

Innenecken
Inside Corners

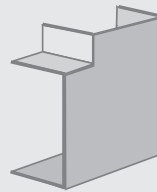

Flachwinkel
Flat Corners

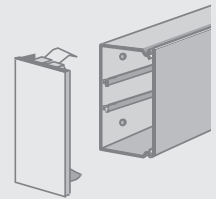

Endstücke
End Caps

Trennstege / Dividers

Typ Type	H	Artikel-Nr. Article-No.
60	60 mm	1699

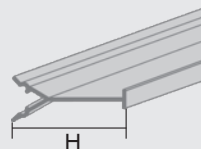

CKE „Elegant“, Hart PVC / CKE „Elegant“, rigid PVC

Installationskanäle Elegant / Installation Trunkings Eleganc

VDE   RoHS konform / compliant

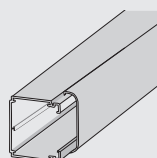
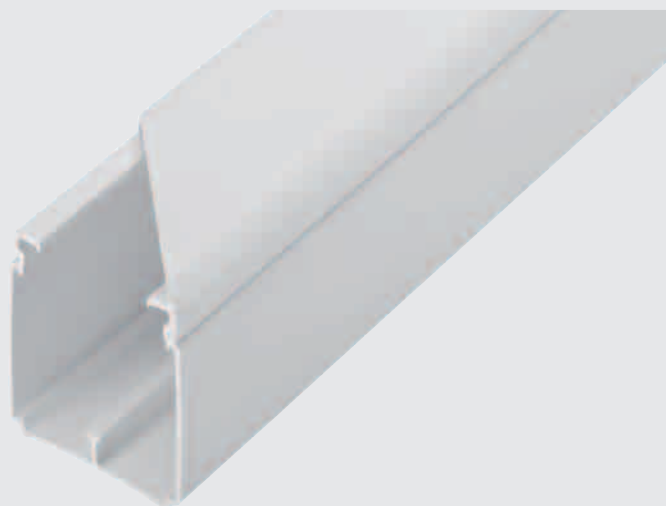

60 x 60

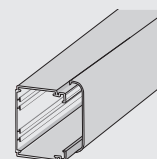

100 x 60

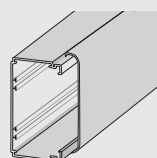

140 x 60

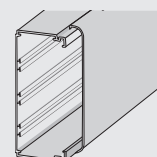

180 x 60

Material: Hart-PVC, schwer entflammbar, selbstverlöschend

Besondere Merkmale:

- Vorgesehen für Trennstegeinbau ab 60 x 60
- Farben ähnlich: reinweiß RAL 9010
- Lieferumfang: Unterteil mit Bodenlochungen (Abstand 200 mm), inkl. Deckel, Länge 2 m
- Mit 2 Kabelklammern

Material: rigid PVC, hardly-inflammable, self-extinguishing

Specific Features:

- Designed for the use of dividers from 60 x 60 onwards
- Colors similar: pure white RAL 9010
- Extent of supply: base with perforated bottom (distance 200 mm), incl. cover, length 2 m
- With 2 cable holders

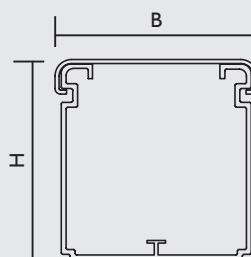

Serie Elegant Trennstege / Dividers

Typ Type	Artikel-Nr. Article-No.
Trennstege / Divider	9052

Farbe Colour	Abmessungen Dimensions B x H / W x H	Länge Length	VE PU	Artikel-Nr. Article-No.
RAL 9010	60 x 60	2 m	18	2205
RAL 9010	100 x 60	2 m	8	2305
RAL 9010	140 x 60	2 m	6	2405
RAL 9010	180 x 60	2 m	6	2505

Symbolische Darstellungen:

Artikel-Nr. / Article-No.			
Außenecken Outside Corners	Innenecken Inside Corners	Flachwinkel Flat Corners	Endstücke End Caps
2215	2225	2245	2235
2315	2325	2345	2335
2415	2425	2445	2435
2515	2525	2545	2535



Außenecken
Outside Corners

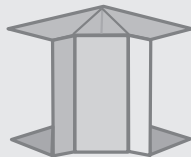

Innenecken
Inside Corners

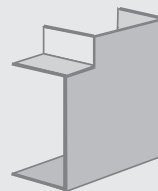

Flachwinkel
Flat Corners

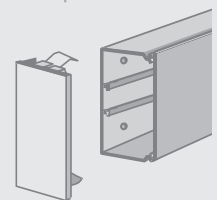

Endstücke
End Caps

Kabelklammern / Cable Clamps

Typ Type	Artikel-Nr. Article-No.
60 x 60	9092
100 x 60	9093
140 x 60	9094
180 x 60	9095

Abzweigstücke / Branch-off Pieces

Typ Type	Artikel-Nr. Article-No.
60 x 60	2285
100 x 60	2385
140 x 60	2485
180 x 60	2585

CKA, Aluminium / CKA, made of aluminium

Installationskanäle aus Aluminium / Installation Trunkings, made of aluminium

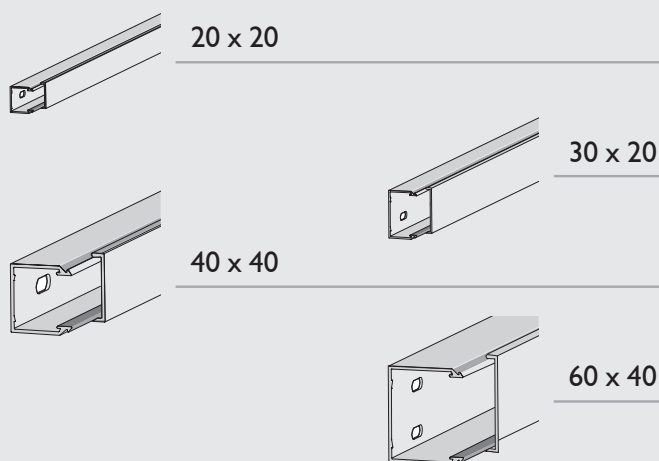
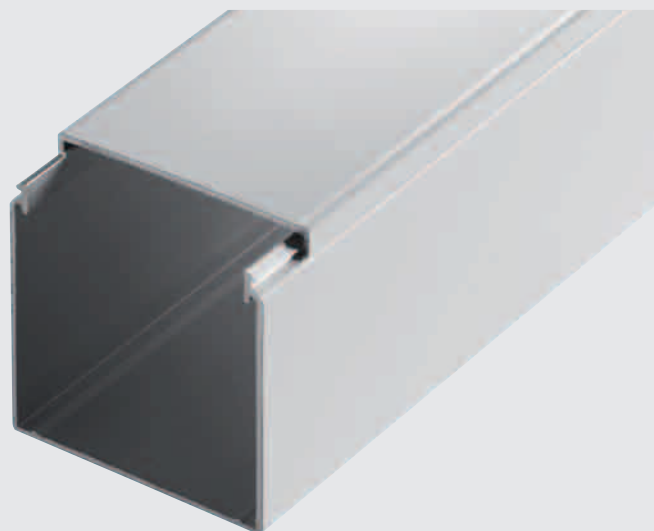

Material: Aluminium, natur eloxiert / beschichtet

Besondere Merkmale:

- Montagefreundliches Zubehör, Leitungshalter (60 x 40), ergänzen bzw. erweitern den Anwendungsbereich
- Farbe: pulverbeschichtet ähnlich reinweiß RAL 9010, natur eloxiert, andere Farben auf Anfrage
- Lieferumfang: Unterteil mit Bodenlochungen (Abstand 250 mm), inkl. Deckel, Länge 2 m

Material: aluminium, anodised, coated

Specific Features:

- Easily assembled accessories, for example dividers (60 x 40) and cable holders, complement or extend the range of application
- Colour: powder-coated similar pure white RAL 9010, anodised, other colours on request
- Extent of supply: base with perforated bottom (distance 250 mm), incl. cover, length 2 m

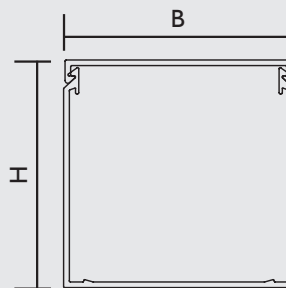

Kabelklammern / Cable Clamps



Typ Type	B x H / W x H in mm	Artikel-Nr. Article-No.
CKA 60 x 40	60 x 40	64321

Farbe Colour	Abmessungen Dimensions B x H / W x H	Länge Length	VE PU	Artikel-Nr. Article-No.
eloxiert / anodised	20 x 20	2 m	48	60100
RAL 9010	20 x 20	2 m	48	60105
eloxiert / anodised	30 x 20	2 m	40	61100
RAL 9010	30 x 20	2 m	40	61105
eloxiert / anodised	40 x 40	2 m	32	63100
RAL 9010	40 x 40	2 m	32	63105
eloxiert / anodised	60 x 40	2 m	24	64100
RAL 9010 Symbolische Darstellungen:	60 x 40	2 m	24	64105

Artikel-Nr. / Article-No.				
Außenecken Outside Corners	Innenecken Inside Corners	Flachwinkel Flat Corners	Farbe Colour	Endstücke End Caps
-	-	-	Kunststoff, schwarz	60130
-	-	-	plastic black	-
-	-	-	Kunststoff, schwarz	61130
-	-	-	plastic black	-
-	-	-	Kunststoff, schwarz	63130
-	-	-	plastic black	-
64120	64110	64140	-	64130
64125	64115	64145	-	-

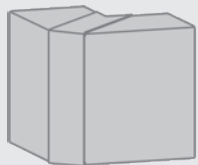

Außenecken
Outside Corners

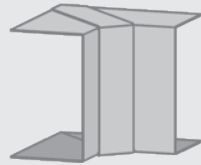

Innenecken
Inside Corners



Flachwinkel
Flat Corners

Stoßverbinder innen / Couplers, internal

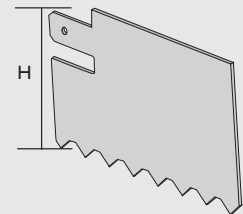

Typ Type	B	H	Material	pro Stoßstelle benötigt / per joint required	VE PU	Artikel-Nr. Article-No.
V 20	-	20	Federstahl / spring steel	1 Stück / pieces	20	60312
V 30	-	30	Federstahl / spring steel	1 Stück / pieces	20	62312
V 40	40	-	Federstahl / spring steel	2 Stück / pieces	20	63312

CKS, Stahlblech / CKS, made of sheet steel

Installationskanäle aus Stahlblech / Installation Trunkings, sheet steel

CE  **RoHS konform / compliant**



Material: Stahlblech, sendzimirverzinkt

Besondere Merkmale:

- Montagefreundliches Zubehör, z.B. Trennstege (ab 100 x 60 mm) und Leitungshalter (ab 60 x 60 mm), ergänzen bzw. erweitern den Anwendungsbereich
- Farbe: pulverbeschichtet ähnlich reinweiß RAL 9010, andere Farben auf Anfrage
- Lieferumfang: Unterteil mit Bodenlochungen (Abstand 250 mm), inkl. Deckel, Länge 2 m

Material: sheet steel, sendzimir zinc-plated

Specific Features:

- Easily assembled accessories, for example dividers (from 100 x 60 mm onwards) and cable holders (from 60 x 60 mm onwards), complement or extend the range of application
- Colour: powder-coated similar pure white RAL 9010, other colours on request
- Extent of supply: base with perforated bottom (distance 250 mm), incl. cover, length 2 m

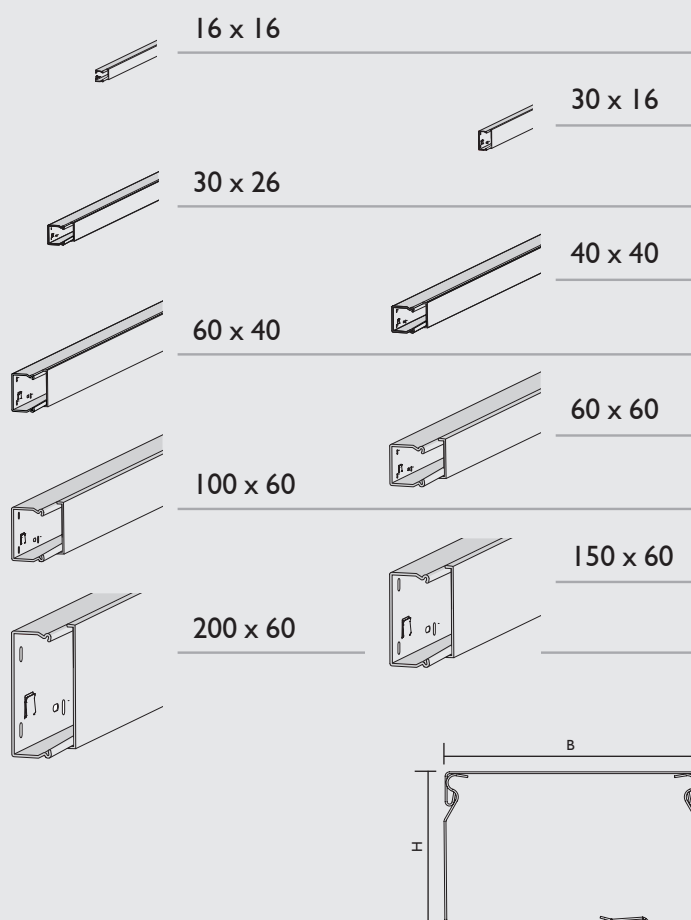

Kabelklammern / Cable Clamps



Typ Type	B x H / W x H in mm	Artikel-Nr. Article-No.
60 x 60	60 x 60	65321
100 x 60	100 x 60	66321
150 x 60	150 x 60	67321
200 x 60	200 x 60	68321

Farbe Colour	Abmessungen Dimensions B x H / W x H	Länge Length	VE PU	Artikel-Nr. Article- No.
verzinkt / zinc-plated	16 x 16	2 m	96	60000
RAL 9010	16 x 16	2 m	84	60005
verzinkt / zinc-plated	30 x 16	2 m	60	61000
RAL 9010	30 x 16	2 m	48	61005
verzinkt / zinc-plated	30 x 26	2 m	36	62000
RAL 9010	30 x 26	2 m	24	62005
verzinkt / zinc-plated	40 x 40	2 m	24	63000
RAL 9010	40 x 40	2 m	24	63005
verzinkt / zinc-plated	60 x 40	2 m	12	64000
RAL 9010	60 x 40	2 m	12	64005
verzinkt / zinc-plated	60 x 60	2 m	12	65000
RAL 9010	60 x 60	2 m	12	65005
verzinkt / zinc-plated	100 x 60	2 m	8	66000
RAL 9010	100 x 60	2 m	8	66005
verzinkt / zinc-plated	150 x 60	2 m	4	67000
RAL 9010	150 x 60	2 m	4	67005
verzinkt / zinc-plated	200 x 60	2 m	4	68000
RAL 9010	200 x 60	2 m	4	68005

Artikel-Nr. / Article-No.			
Außenecken Outside Corners	Innenecken Inside Corners	Flachwinkel Flat Corners	Endstücke End Caps
-	Farbe: Kunststoff, schwarz	Kunststoff, schwarz	60030
-	Colour: plastic black	plastic black	60030
-	Farbe: Kunststoff, schwarz	Kunststoff, schwarz	61030
-	Colour: plastic black	plastic black	61030
-	Farbe: Kunststoff, schwarz	Kunststoff, schwarz	62030
-	Colour: plastic black	plastic black	62030
-	-	-	63030
-	-	-	63035
-	-	-	64030
-	-	-	64035
65010	65020	65040	65030
65015	65025	65045	65035
66010	66020	66040	66030
66015	66025	66045	66035
67010	67020	67040	67030
67015	67025	67045	67035
68010	68020	68040	68030
68015	68025	68045	68035

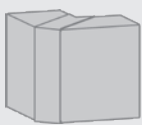

Außenecken
Outside Corners

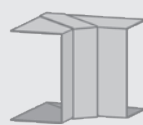

Innenecken
Inside Corners



Flachwinkel
Flat Corners

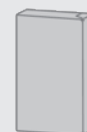

Endstücke
End Caps

Stoßverbinder innen / Couplers, internal

Dient gleichzeitig der mechanischen und elektrischen Verbindung /
simultaneously serves as a mechanical and electrical coupler

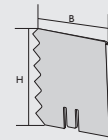

Typ Type	B x H / W x H in mm	Material	je Stoßstelle / per joint	VE PU	Artikel-Nr. Article-No.
16 x 16	16 x 16	messing / brass	1 St. / pce.	10	60310
30 x 16	30 x 16	messing / brass	1 St. / pce.	10	61310
30 x 26	30 x 26	messing / brass	1 St. / pce.	10	62310
40 x 40	40 x 40	verzinkt / zinc-plated	2 St. / pces.	20	64310
60 x 40	60 x 40	verzinkt / zinc-plated	2 St. / pces.	20	64310

Typ Type	B x H / W x H in mm	Material	je Stoßstelle / per joint	VE PU	Artikel-Nr. Article-No.
60 x 60	60 x 60	verzinkt / zinc-plated	2 St. / pces.	20	66310
100 x 60	100 x 60	verzinkt / zinc-plated	2 St. / pces.	20	66310
150 x 60	150 x 60	verzinkt / zinc-plated	2 St. / pces.	20	66310
200 x 60	200 x 60	verzinkt / zinc-plated	2 St. / pces.	20	66310

CK Zubehör / CK Accessories

Deckel für CK / Covers for CK

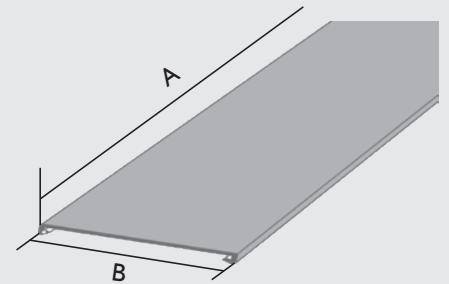

Farbe / Colour	B	A	Material	Artikel-Nr. Article-No.
RAL 9001	60	2 m	Hart-PVC / rigid PVC	5223
RAL 7035	60	2 m	Hart-PVC / rigid PVC	5041
RAL 9010	60	2 m	Hart-PVC / rigid PVC	5235
RAL 9001	90	2 m	Hart-PVC / rigid PVC	5282
RAL 7035	90	2 m	Hart-PVC / rigid PVC	5042
RAL 9010	90	2 m	Hart-PVC / rigid PVC	5283
RAL 9001	110	2 m	Hart-PVC / rigid PVC	5224
RAL 7035	110	2 m	Hart-PVC / rigid PVC	5043
RAL 9010	110	2 m	Hart-PVC / rigid PVC	5365
RAL 9001	130	2 m	Hart-PVC / rigid PVC	5225
RAL 7035	130	2 m	Hart-PVC / rigid PVC	5044
RAL 9010	130	2 m	Hart-PVC / rigid PVC	5375

Farbe / Colour	B	A	Material	Artikel-Nr. Article-No.
RAL 9001	150	2 m	Hart-PVC / rigid PVC	5226
RAL 7035	150	2 m	Hart-PVC / rigid PVC	5045
RAL 9010	150	2 m	Hart-PVC / rigid PVC	5385
RAL 9001	190	2 m	Hart-PVC / rigid PVC	5227
RAL 7035	190	2 m	Hart-PVC / rigid PVC	5046
RAL 9010	190	2 m	Hart-PVC / rigid PVC	5395
RAL 9001	230	2 m	Hart-PVC / rigid PVC	5206
RAL 7035	230	2 m	Hart-PVC / rigid PVC	5047
RAL 9010	230	2 m	Hart-PVC / rigid PVC	5209

Trennstege / Divider

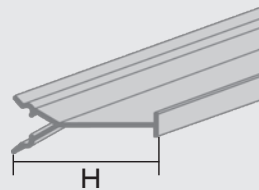

Typ Type	H	Material	Artikel-Nr. Article-No.
60	60 mm	Hart-PVC / rigid PVC	9050

Kabelklammern / Cable Clamps

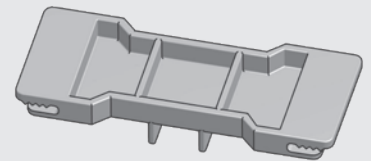

Typ Type	B x H / W x H in mm	Material	Artikel-Nr. Article-No.
60 x 60	60 x 60	Polypropylen	9083
90 x 60	90 x 60	Polypropylen	9084
110 x 60	110 x 60	Polypropylen	9085
130 x 60	130 x 60	Polypropylen	9086
150 x 60	150 x 60	Polypropylen	9087
190 x 60	190 x 60	Polypropylen	9080
230 x 60	230 x 60	Polypropylen	9088

CKS Zubehör / CKS Accessories

Potentialausgleichsleitungen / Voltage Equalising Cables

2,5 mm², mit Flachstecker, Länge: 300 mm / 2,5 mm² with flat blade connector, length 300 mm

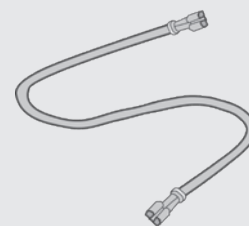

Typ Type	Länge / length	Artikel-Nr. Article-No.
2,5 mm ²	300 mm	300 62

Kantenschutzring / Edge Protection Ring

Nicht für CKA / not for CKA

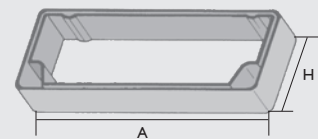

Typ Type	H	A	Material	Material	Artikel-Nr. Article-No.
40 x 40	40	40	Hart PVC / rigid PVC	schwarz / black	63340
60 x 40	60	40	Hart PVC / rigid PVC	schwarz / black	64340
60 x 60	60	60	Weich-PVC / soft PVC	schwarz / black	65340
100 x 60	60	100	Weich-PVC / soft PVC	schwarz / black	66340
150 x 60	60	150	Weich-PVC / soft PVC	schwarz / black	67340
200 x 60	60	200	Weich-PVC / soft PVC	schwarz / black	68340

Trennstege / Dividers

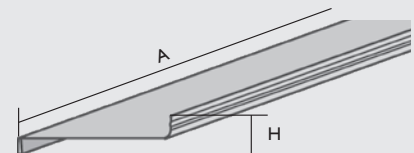

Typ Type	H	A	Farbe / Colour	Artikel-Nr. Article-No.
45	45 mm	2 m	verzinkt / zinc-plated	103 00
45	45 mm	2 m	PVC	103 02

„Lehnen Sie sich zurück!“



Fotografie, Grafik, Text, all rights reserved by MoS Media Group, BRD#TM, V 10, LICATEC®

**„Sie haben den direkten
Kontakt zu Licatec
gefunden!“**



Licatec GmbH
Licht und Kabelführungssysteme
Alfred-Nobel-Str. 2-14
50226 Frechen
Germany
Tel.: +49 (0) 22 34 / 9 55 66 - 0
Fax: +49 (0) 22 34 / 9 55 66 - 955

Licatec GmbH
Leuchtenbau und Kabelführungssysteme
Erzstr. 7
09618 Brand-Erbisdorf
Germany
Tel.: +49 (0) 3 73 22 / 33 5 - 0
Fax: +49 (0) 3 73 22 / 25 13